

Fitting / Order form

M5 Corpus

Prices on request: 17 December 2018



M5 Corpus



Midwheel drive wheelchair with full 6 wheel independent suspension
Standard delivered with air filled tires.

Corpus seating system, prepared to be equipped with
powered backrest, legrest, seat elevation and tilt

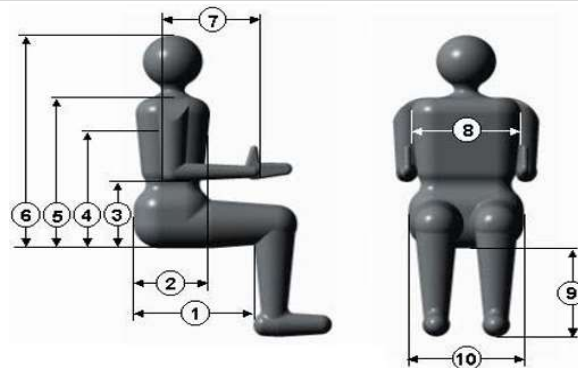
Dealer information							
Customer (name / code)	/						
Contact							
Address							
Post code / City	/						
Phone / Fax	/						
Client Information							
Name	/						
Address							
Post code / City	/						
Phone							
E-mail							
Diagnosis		Weight:	kg	3:	cm	7:	cm
		Height:	cm	4:	cm	8:	cm
		1:	cm	5:	cm	9:	cm
		2:	cm	6:	cm	10:	cm
Fitting date							
Fitting date (dd-mm-yyyy)							
		Position	Price	Funding	Additional	<input checked="" type="checkbox"/> Required choice <input type="checkbox"/> / <input type="checkbox"/> Optional choice <input type="checkbox"/> / <input type="checkbox"/> Default required option	
		Article code	Left	Right	incl VAT	incl VAT	code
		Chassis					
M5 CORPUS	107729-99-0	<input checked="" type="checkbox"/>					
Language user manuals							
LANGUAGE							
ESP							
ESP	107998-99-0	<input type="checkbox"/>					

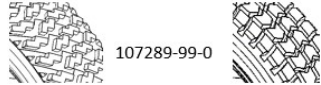

Anatomic Dimension

Accent colour					
COVER ACCENT COLOUR GALACTIC GREEN	107831-99-0	<input type="radio"/>			
COVER ACCENT COLOUR MIDNIGHT BLACK	107832-99-0	<input type="radio"/>			
COVER ACCENT COLOUR OCEAN BLUE	107833-99-0	<input type="radio"/>			
COVER ACCENT COLOUR POWER PINK	107834-99-0	<input type="radio"/>			
COVER ACCENT COLOUR RADIANT RED	107835-99-0	<input type="radio"/>			
COVER ACCENT COLOUR SUNBURST ORANGE	107836-99-0	<input type="radio"/>			
COVER ACCENT COLOUR TITAN BLUE	107849-99-0	<input type="radio"/>			
COVER ACCENT COLOUR PHANTOM GREY	107850-99-0	<input type="radio"/>			
Drive wheels					
WHEELS 3.00x8" AIR FILLED TIRES BLACK	107854-99-0	<input checked="" type="radio"/>			
WHEELS 3.00x8" AIR FILLED TIRES/SNOW AND MUD BLACK	107289-99-0	<input type="radio"/>			
WHEELS 3.00x8" SOLID TIRES BLACK	107855-99-0	<input type="radio"/>			
					
Caster wheels					
WHEELS 210X65 AIR FILLED TIRES BLACK	107852-99-0	<input checked="" type="radio"/>			
WHEELS 210X65 SOLID TIRES BLACK	107851-99-0	<input type="radio"/>			
Batteries					
BATTERIES, 73Ah, SET OF 2	101989-99-0	<input checked="" type="radio"/>			
WITHOUT BATTERIES	100661-99-0	<input type="radio"/>			
Charger					
WITHOUT CHARGER	100662-99-0	<input type="radio"/>			
CHARGER PERMOBIL 24V/8A	104877-99-0	<input checked="" type="radio"/>			
Light kit					
REFLECTOR KIT	105717-99-0	<input checked="" type="radio"/>			
LIGHT KIT	107741-99-0	<input type="radio"/>			
LIGHT KIT (LUGG CAR.)	107740-99-0	<input type="radio"/>			
LIGHT ON LUGGAGE CARRIER AND CHASSIS	108099-99-0	<input type="checkbox"/>			
Accessories chassis					
LUGGAGE CARRIER WITH REFLECTORS	107459-99-0	<input type="radio"/>			
LUGGAGE CARRIER WITH TAIL LIGHTS	107204-99-0	<input type="radio"/>			
LIGHT ON LUGGAGE CARRIER AND CHASSIS	108099-99-0	<input type="checkbox"/>			
PREPARED FOR DAHL CARLOCK	108254-99-0	<input type="checkbox"/>			
REMOTE STOP	107083-99-0	<input type="checkbox"/>			
TARPAULIN/RAINCOVER FOR ALL MODLES (NYLON)	101888-99-0	<input type="checkbox"/>			
					
Seat assembly					
SEAT HEIGHT FIXED	107097-99-0	<input checked="" type="radio"/>			
POWERED SEAT LIFT	107098-99-0	<input type="radio"/>			
FIXED SEAT ANGEL	107096-99-0	<input checked="" type="radio"/>			
POWERED ADJ. SEAT TILT 50°	107095-99-0	<input type="radio"/>			
WITHOUT ANTERIOR/NEGATIVE SEAT TILT	107093-99-0	<input checked="" type="radio"/>			
5° ACTIVE SEATING	107099-99-0	<input type="radio"/>			
10° ACTIVE SEATING	107090-99-0	<input type="radio"/>			
20° ACTIVE SEATING (REQ. LEGREST(X)+KNEESUPPORT)	107091-99-0	<input type="radio"/>			
					

Seat											
SEAT CORPUS		107022-99-0				<input checked="" type="checkbox"/>					
Seat sizes											
		Depth									
Size (mm)		370	395	420	445	470	495	520	545	570	
Width	420	<input type="checkbox"/>	<input type="checkbox"/>	<input type="checkbox"/>	<input type="checkbox"/>	<input type="checkbox"/>	<input type="checkbox"/>	<input type="checkbox"/>	<input type="checkbox"/>	<input type="checkbox"/>	
	470	<input type="checkbox"/>	<input type="checkbox"/>	<input checked="" type="checkbox"/>	<input type="checkbox"/>	<input type="checkbox"/>	<input type="checkbox"/>	<input type="checkbox"/>	<input type="checkbox"/>	<input type="checkbox"/>	
	520	<input type="checkbox"/>	<input type="checkbox"/>	<input type="checkbox"/>	<input type="checkbox"/>	<input type="checkbox"/>	<input type="checkbox"/>	<input type="checkbox"/>	<input type="checkbox"/>	<input type="checkbox"/>	
	570	<input type="checkbox"/>	<input type="checkbox"/>	<input type="checkbox"/>	<input type="checkbox"/>	<input type="checkbox"/>	<input type="checkbox"/>	<input type="checkbox"/>	<input type="checkbox"/>	<input type="checkbox"/>	
Seat cushion											
SEAT CUSHION VINYL		10XXXX-99-0				<input checked="" type="checkbox"/>					
SEAT CUSHION TEXTILE		10XXXX-99-0				<input type="checkbox"/>					
WITHOUT SEAT CUSHION		105118-99-0				<input type="checkbox"/>					
ERGO SUPPORTS SEAT CUSHION		105219-99-0				<input type="checkbox"/>					
Adjustment backrest											
POWERED ADJ. BACKREST 150° (LA28)		107825-99-0				<input type="checkbox"/>					
POWERED ADJ. BACKREST 180° (LA28)		107755-99-0				<input type="checkbox"/>					
MANUAL ADJ. BACKREST (BRACKET LA28)		107827-99-0				<input checked="" type="checkbox"/>					
BACKREST FIXED		105066-99-0				<input checked="" type="checkbox"/>					
BACKREST BIO-MECH		105067-99-0				<input type="checkbox"/>					
Backrest type											
SHORT		107262-99-0				<input type="checkbox"/>					
STANDARD		107264-99-0				<input checked="" type="checkbox"/>					
DIRECT BACKREST ADAPTER		107261-99-0				<input type="checkbox"/>					
TUBELAR BACKREST ADAPTER		107265-99-0				<input type="checkbox"/>					
WITHOUT BACKREST SHELL		107272-99-0				<input type="checkbox"/>					
Backrest sizes											
		Short	Standard heights								
Size (mm)		470	545	570	595	620	645	670			
Width	360	<input type="checkbox"/>	<input type="checkbox"/>	<input type="checkbox"/>	<input type="checkbox"/>	<input type="checkbox"/>	<input type="checkbox"/>	<input type="checkbox"/>			
	410	<input type="checkbox"/>	<input type="checkbox"/>	<input type="checkbox"/>	<input checked="" type="checkbox"/>	<input type="checkbox"/>	<input type="checkbox"/>	<input type="checkbox"/>			
	460	<input type="checkbox"/>	<input type="checkbox"/>	<input type="checkbox"/>	<input type="checkbox"/>	<input type="checkbox"/>	<input type="checkbox"/>	<input type="checkbox"/>			
	510	<input type="checkbox"/>	<input type="checkbox"/>	<input type="checkbox"/>	<input type="checkbox"/>	<input type="checkbox"/>	<input type="checkbox"/>	<input type="checkbox"/>			
Backrest cushion											
BACKREST CUSHION VINYL		10XXXX-99-0				<input checked="" type="checkbox"/>					
BACKREST CUSHION TEXTILE		10XXXX-99-0				<input type="checkbox"/>					
WITHOUT BACKREST CUSHION		105117-99-0				<input type="checkbox"/>					
ERGO SUPPORTS BACK SMALL (5 CM DEEP)		105569-99-0				<input checked="" type="checkbox"/>					
ERGO SUPPORTS BACK LARGE (7 CM DEEP)		<input type="checkbox"/>	<input type="checkbox"/>	105570-99-0		<input type="checkbox"/>					



Agility Max Contour										
(W)	(H)		Height		(MH)	Mounting height				
	Size ("/mm)	16"	18"	20"		16"	18"	20"		
Width	14"/355mm	<input type="radio"/>	<input type="radio"/>	<input type="radio"/>		470mm	<input type="radio"/>	<input type="radio"/>	<input type="radio"/>	
	15"/380mm	<input type="radio"/>	<input type="radio"/>	<input type="radio"/>		459mm	<input type="radio"/>	<input type="radio"/>	<input type="radio"/>	
	16"/405mm	<input type="radio"/>	<input type="radio"/>	<input type="radio"/>		520mm	<input type="radio"/>	<input type="radio"/>	<input type="radio"/>	
	17"/430mm	<input type="radio"/>	<input type="radio"/>	<input type="radio"/>		545mm	<input type="radio"/>	<input type="radio"/>	<input type="radio"/>	
	18"/455mm	<input type="radio"/>	<input type="radio"/>	<input type="radio"/>		570mm	<input type="radio"/>	<input type="radio"/>	<input type="radio"/>	
	19"/485mm	<input type="radio"/>	<input type="radio"/>	<input type="radio"/>		595mm	<input type="radio"/>	<input type="radio"/>	<input type="radio"/>	
	20"/510mm	<input type="radio"/>	<input type="radio"/>	<input type="radio"/>		620mm	<input type="radio"/>	<input type="radio"/>	<input type="radio"/>	
						645mm	<input type="radio"/>	<input type="radio"/>	<input type="radio"/>	
Height Agility lateral supports										
AGILITY LATERAL SUPPORTS LOW POSITION (STANDARD)						108538-99-0	<input checked="" type="radio"/>	<input type="radio"/>	<input type="radio"/>	
AGILITY LATERAL SUPPORTS HIGH POSITION						108537-99-0	<input type="radio"/>	<input type="radio"/>	<input type="radio"/>	
Mounting armrests										
WIDTH BETWEEN ARMRESTS: NARROW (38-48CM)						107251-99-0	<input checked="" type="radio"/>	<input type="radio"/>	<input type="radio"/>	
WIDTH BETWEEN ARMRESTS: WIDE (48-58CM)						107252-99-0	<input type="radio"/>	<input type="radio"/>	<input type="radio"/>	
WIDTH BETWEEN ARMRESTS SET TO 380MM						105083-99-0	<input type="radio"/>	<input type="radio"/>	<input type="radio"/>	
WIDTH BETWEEN ARMRESTS SET TO 430MM						105084-99-0	<input checked="" type="radio"/>	<input type="radio"/>	<input type="radio"/>	
WIDTH BETWEEN ARMRESTS SET TO 480MM						105085-99-0	<input type="radio"/>	<input type="radio"/>	<input type="radio"/>	
WIDTH BETWEEN ARMRESTS SET TO 530MM						105086-99-0	<input type="radio"/>	<input type="radio"/>	<input type="radio"/>	
WIDTH BETWEEN ARMRESTS SET TO 580MM						105082-99-0	<input type="radio"/>	<input type="radio"/>	<input type="radio"/>	
ARMREST HEIGHT POS 1: 230MM (FROM SEAT PAN)						106631-99-0	<input type="radio"/>	<input type="radio"/>	<input type="radio"/>	
ARMREST HEIGHT POS 2: 255MM (FROM SEAT PAN)						106632-99-0	<input type="radio"/>	<input type="radio"/>	<input type="radio"/>	
ARMREST HEIGHT POS 3: 280MM (FROM SEAT PAN)						106633-99-0	<input checked="" type="radio"/>	<input type="radio"/>	<input type="radio"/>	
ARMREST HEIGHT POS 4: 305MM (FROM SEAT PAN)						106634-99-0	<input type="radio"/>	<input type="radio"/>	<input type="radio"/>	
ARMREST HEIGHT POS 5: 330MM (FROM SEAT PAN)						106635-99-0	<input type="radio"/>	<input type="radio"/>	<input type="radio"/>	
ARMREST HOLDERS FIXED						105070-99-0	<input checked="" type="radio"/>	<input type="radio"/>	<input type="radio"/>	
ARMREST HOLDERS SWIVEL						105072-99-0	<input type="radio"/>	<input type="radio"/>	<input type="radio"/>	
Armrests										
	Left				Right					
	260	335	410	460	260	335	410	460		
	<input type="radio"/>	<input type="radio"/>	<input type="radio"/>	<input type="radio"/>	<input type="radio"/>	<input type="radio"/>	<input type="radio"/>	<input type="radio"/>	<input type="radio"/>	
	<input type="radio"/>	<input type="radio"/>	<input type="radio"/>	<input type="radio"/>	<input type="radio"/>	<input type="radio"/>	<input type="radio"/>	<input type="radio"/>	<input type="radio"/>	
WITHOUT ARMREST	<input type="radio"/>	<input type="radio"/>	<input type="radio"/>	<input type="radio"/>	<input type="radio"/>	<input type="radio"/>	<input type="radio"/>	<input type="radio"/>		
TEXTIEL ARMREST	<input type="radio"/>	<input type="radio"/>	<input type="radio"/>	<input type="radio"/>	<input type="radio"/>	<input type="radio"/>	<input type="radio"/>	<input type="radio"/>		
VINYL ARMREST	<input type="radio"/>	<input checked="" type="radio"/>	<input type="radio"/>	<input type="radio"/>	<input type="radio"/>	<input checked="" type="radio"/>	<input type="radio"/>	<input type="radio"/>		
GEL ARMREST	<input type="radio"/>	<input type="radio"/>	<input type="radio"/>	<input type="radio"/>	<input type="radio"/>	<input type="radio"/>	<input type="radio"/>	<input type="radio"/>		

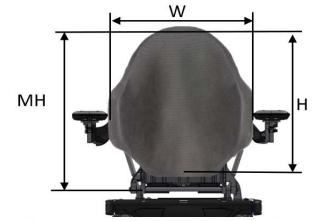

108538-99-0



108537-99-0

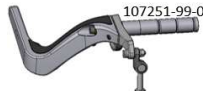

107251-99-0



107252-99-0



105082-99-0 / 105086-99-0



106631-99-0 / 106635-99-0



105070-99-0















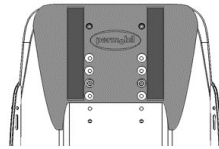





105072-99-0

Adjustment legrest						
POWERED ADJ. LEGREST M5 CORPUS (LA28)	107926-99-0	<input type="radio"/>				
POWERED ADJ. LEGREST M5 COPUS WITH VS LEGREST	107925-99-0	<input type="radio"/>				
MANUAL ADJUSTMENT LEGREST (BRACKET LA28)	107763-99-0	<input checked="" type="radio"/>				
Legrest						
LEGREST W. 205MM LENGTH COMPENSATION	107012-99-0	<input checked="" type="radio"/>				<p>107012-99-0 107184-99-0</p> <p>107185-99-0</p> <p>107219-99-0 107220-99-0</p>
LEGREST W. 185MM LENGTH COMPENSATION	107184-99-0	<input type="radio"/>				
LEGREST WITH POW. LENGTH COMPENSATION 20CM (X)	107185-99-0	<input type="radio"/>				
LEGREST W. 32-41(+10)CM HEIGHT ADJ. FOOTPL.	107219-99-0	<input type="radio"/>				
LEGREST W. 35-44(+10)CM HEIGHT ADJ. FOOTPL.	107220-99-0	<input type="radio"/>				
WITHOUT LEGREST	105760-99-0	<input type="radio"/>				
Footplates						
DUAL FOOTPLATE 16CM LEG LENGTH 29-50CM	105436-99-0	<input checked="" type="radio"/>				<p>105436-99-0 2x160mm 105437-99-0 2x200mm</p> <p>105438-99-0 2x160mm 105439-99-0 2x200mm</p> <p>106760-99-0 1x320/210</p>
DUAL FOOTPLATE 20CM LEG LENGTH 29-50CM	105437-99-0	<input type="radio"/>				
FOOTPLATE 1 PIECE LEG LENGTH 29-50CM	106760-99-0	<input type="radio"/>				
DUAL FOOTPLATE 16CM LEG LENGTH 14-30CM	105438-99-0	<input type="radio"/>				
DUAL FOOTPLATE 20CM LEG LENGTH 14-30CM	105439-99-0	<input type="radio"/>				
DUAL FOOTPLATE 16CM LEG LENGTH 25-50CM (PWR FOOT)	106967-99-0	<input type="radio"/>				<p>106967-99-0 2x160mm 106971-99-0 2x200mm</p> <p>106968-99-0 2x160mm 106970-99-0 2x200mm</p> <p>106969-99-0 1x420mm 106968-99-0 1x420mm</p>
FOOTPLATE 1P. 42CM LEG LENGTH 25-50CM (PWR FOOT)	106969-99-0	<input type="radio"/>				
DUAL FOOTPLATE 20CM LEG LENGTH 25-50CM (PWR FOOT)	106971-99-0	<input type="radio"/>				
DUAL FOOTPLATE 16CM LEG LENGTH <25CM (PWR FOOT)	106966-99-0	<input type="radio"/>				
DUAL FOOTPLATE 20CM LEG LENGTH <25CM (PWR FOOT)	106970-99-0	<input type="radio"/>				
FOOTPLATE 1P. 42CM LEG LENGTH <25CM (PWR FOOT)	106968-99-0	<input type="radio"/>				
DUAL FOOTPLATE 16CM	107453-99-0	<input type="radio"/>				<p>104646-99-0 2x160mm 106008-99-0 2x200mm</p>
DUAL FOOTPLATE 20CM	106008-99-0	<input type="radio"/>				
FOOTPLATE CHOICE NOT REQUIRED	106154-99-0	<input type="radio"/>				

Accessories seat

Headrest						
HEAD SUPPORT, ADJUSTABLE TEXTILE(BLACK)	106336-99-0	<input type="radio"/>				<p>106331-99-0 106332-99-0 106337-99-0 106334-99-0 106336-99-0 106333-99-0 106338-99-0 106335-99-0</p> <p>340x130mm 250x125mm 180x110mm</p> <p>107712-99-0 107714-99-0 107711-99-0 107713-99-0 107708-99-0 107710-99-0 107719-99-0 107715-99-0 107716-99-0 107717-99-0 107718-99-0 107709-99-0 107719-99-0 107718-99-0 107715-99-0 107717-99-0 108580-99-0 108579-99-0 108582-99-0 108581-99-0 108584-99-0 108583-99-0</p> <p>STD LOW BACK / AGILITY 107714-99-0 107713-99-0 108579-99-0 107712-99-0 107711-99-0 108580-99-0 107710-99-0 107709-99-0 108581-99-0 107708-99-0 107719-99-0 108582-99-0 107718-99-0 107717-99-0 108583-99-0 107716-99-0 107715-99-0 108584-99-0</p>
HEAD SUPPORT, ADJUSTABLE TEXTILE(BLACK)/SHORT BACK	106337-99-0	<input type="radio"/>				
HEAD SUPPORT, ADJUSTABLE VINYL	106331-99-0	<input type="radio"/>				
HEAD SUPPORT, ADJUSTABLE VINYL/SHORT BACK	106338-99-0	<input type="radio"/>				
HEAD SUPPORT "ERGO" TEXTILE(BLACK)	106333-99-0	<input type="radio"/>				
HEAD SUPPORT "ERGO" TEXT. (BLACK) SHORT BACK	106335-99-0	<input type="radio"/>				
HEADREST ORIGINAL 340x130 LONG HOLDER, STD BACK	107716-99-0	<input type="radio"/>				
HEADREST ORIGINAL 340x130 LONG HOLDER, SHORT BACK	107715-99-0	<input type="radio"/>				
HEADREST ORIGINAL 340x130 STD HOLDER, STD BACK	107718-99-0	<input type="radio"/>				
HEADREST ORIGINAL 340x130 STD HOLDER, SHORT BACK	107717-99-0	<input type="radio"/>				
HEADREST ORIGINAL 250x125 LONG HOLDER, STD BACK	107708-99-0	<input type="radio"/>				
HEADREST ORIGINAL 250x125 LONG HOLDER, SHORT BACK	107719-99-0	<input type="radio"/>				
HEADREST ORIGINAL 250x125 STD HOLDER, STD BACK	107710-99-0	<input type="radio"/>				
HEADREST ORIGINAL 250x125 STD HOLDER, SHORT BACK	107709-99-0	<input type="radio"/>				
HEADREST ORIGINAL 180x110 LONG HOLDER, STD BACK	107712-99-0	<input type="radio"/>				
HEADREST ORIGINAL 180x110 LONG HOLDER, SHORT BACK	107711-99-0	<input type="radio"/>				
HEADREST ORIGINAL 180x110 STD HOLDER, STD BACK	107714-99-0	<input type="radio"/>				
HEADREST ORIGINAL 180x110 STD HOLDER, SHORT BACK	107713-99-0	<input type="radio"/>				
HEADREST ORIGINAL 180x110 STD HOLDER, AGILITY	108579-99-0	<input type="radio"/>				
HEADREST ORIGINAL 180x110 LONG HOLDER, AGILITY	108580-99-0	<input type="radio"/>				
HEADREST ORIGINAL 250x125 STD HOLDER, AGILITY	108581-99-0	<input type="radio"/>				
HEADREST ORIGINAL 250x125 LONG HOLDER, AGILITY	108582-99-0	<input type="radio"/>				
HEADREST ORIGINAL 340x130 STD HOLDER, AGILITY	108583-99-0	<input type="radio"/>				
HEADREST ORIGINAL 340x130 LONG HOLDER, AGILITY	108584-99-0	<input type="radio"/>				
Facial support pad / switch Left						
SWING AWAY CHIN BOOM ASSY SUPPORT STD LEFT/HIGH	107860-99-0	<input type="radio"/>				<p>107860-99-0 107941-99-0</p> <p>107861-99-0 107944-99-0</p> <p>107858-99-0 107931-99-0</p> <p>107859-99-0 107935-99-0</p>
SWING AWAY CHIN BOOM ASSY SUPPORT LONG LEFT/HIGH	107861-99-0	<input type="radio"/>				
SWING AWAY CHIN BOOM ASSY F. HEADREST LEFT/HIGH	107858-99-0	<input type="radio"/>				
SWING AWAY ASSY W. TASH MICRO LIGHT LEFT/HIGH	107859-99-0	<input type="radio"/>				
Facial support pad / switch Right						
SWING AWAY ASSY W. FACIAL SUPPORT STD RIGHT/HIGH	107941-99-0	<input type="radio"/>				<p>107858-99-0 107931-99-0</p> <p>107859-99-0 107935-99-0</p>
SWING AWAY ASSY W. FACIAL SUPPORT LONG RIGHT/HIGH	107944-99-0	<input type="radio"/>				
SWING AWAY EGG SW. ASSY F. HEADREST RIGHT/HIGH	107931-99-0	<input type="radio"/>				
SWING AWAY ASSY W. TASH MICRO LIGHT RIGHT/HIGH	107935-99-0	<input type="radio"/>				
Extension cable						
EXTENSION CABLE 3MM STEREO, L=1M	105931-99-0	<input type="radio"/>				
EXTENSION CABLE 3MM STEREO, L=2M	105932-99-0	<input type="radio"/>				

Lateral support						
LATERAL SUPP. LEFT TEXT (MESH) 150x140 SMALL (A)	107412-99-0	<input type="radio"/>				<p>A: 150x140mm 107412-99-0 107413-99-0</p> <p>F: 220x90mm 107414-99-0 107415-99-0</p> <p>E: 220x50mm 107416-99-0 107417-99-0</p>
LATERAL SUPP. LEFT TEXT (MESH) 220x90 MEDIUM (F)	107414-99-0	<input type="radio"/>				
LATERAL SUPP. LEFT TEXT (MESH) 220x150 LARGE (E)	107416-99-0	<input type="radio"/>				
LATERAL SUPPORT ORIGINAL LEFT 180X130	107720-99-0	<input type="radio"/>				
LATERAL SUPPORT ORIGINAL LEFT 130X80	107722-99-0	<input type="radio"/>				
LATERAL SUPP. RIGHT TEXT (MESH) 150x140 SMALL (A)	107413-99-0		<input type="radio"/>			<p>180x130mm 107720-99-0 107721-99-0</p> <p>130x80mm 107722-99-0 107723-99-0</p>
LATERAL SUPP. RIGHT TEXT (MESH) 220x90 MEDIUM (F)	107415-99-0		<input type="radio"/>			
LATERAL SUPP. RIGHT TEXT (MESH) 220x150 LARGE (E)	107417-99-0		<input type="radio"/>			
LATERAL SUPPORT ORIGINAL RIGHT 180X130	107721-99-0		<input type="radio"/>			
LATERAL SUPPORT ORIGINAL RIGHT 130X80	107723-99-0		<input type="radio"/>			
Thigh supports						
THIGH SUPPORT LEFT TEXT. (MESH) 110x90 SMALL (B)	107392-99-0	<input type="radio"/>				<p>G: 300x90mm 107390-99-0 107391-99-0</p> <p>B: 90x110mm 107382-99-0 107393-99-0</p> <p>C: 200x90mm 107394-99-0 107395-99-0</p> <p>J: 165x120mm 107396-99-0 107397-99-0</p>
THIGH SUPPORT LEFT TEXT. (MESH) 165x120 MEDIUM (J)	107396-99-0	<input type="radio"/>				
THIGH SUPPORT LEFT TEXT. (MESH) 200x90 LARGE (C)	107394-99-0	<input type="radio"/>				
THIGH SUPPORT LEFT TEXT. (MESH) 300x90 XLARGE (G)	107390-99-0	<input type="radio"/>				
THIGH SUPPORT RIGHT TEXT. (MESH) 110x90 SMALL (B)	107393-99-0		<input type="radio"/>			
THIGH SUPPORT RIGHT TEXT. (MESH) 165x120 MEDIUM (J)	107397-99-0		<input type="radio"/>			
THIGH SUPPORT RIGHT TEXT. (MESH) 200x90 LARGE (C)	107395-99-0		<input type="radio"/>			
THIGH SUPPORT RIGHT TEXT. (MESH) 300x90 XLARGE (G)	107391-99-0		<input type="radio"/>			
Hip supports						
HIP SUPPORT LEFT TEXT. (MESH) 110x90 SMALL (B)	107400-99-0	<input type="radio"/>				<p>A: 150x140mm 107398-99-0 107399-99-0</p> <p>B: 90x110mm 107400-99-0 107401-99-0</p> <p>C: 200x90mm 107402-99-0 107403-99-0</p> <p>D: 200x200mm 107404-99-0 107405-99-0</p>
HIP SUPPORT LEFT TEXT. (MESH) 150x140 MEDIUM (A)	107398-99-0	<input type="radio"/>				
HIP SUPPORT LEFT TEXT. (MESH) 200x90 LARGE (C)	107402-99-0	<input type="radio"/>				
HIP SUPPORT LEFT TEXT. (MESH) 200x200 XLARGE (D)	107404-99-0	<input type="radio"/>				
HIP SUPPORT RIGHT TEXT. (MESH) 110x90 SMALL (B)	107401-99-0		<input type="radio"/>			
HIP SUPPORT RIGHT TEXT. (MESH) 150x140 MEDIUM (A)	107399-99-0		<input type="radio"/>			
HIP SUPPORT RIGHT TEXT. (MESH) 200x90 LARGE (C)	107403-99-0		<input type="radio"/>			
HIP SUPPORT RIGHT TEXT. (MESH) 200x200 XLARGE (D)	107405-99-0		<input type="radio"/>			
Calf supports						
CALF SUPPORTS S (B) 110x90 (MESH)	105252-99-0	<input type="radio"/>				<p>A: 150x140mm 105250-99-0 106190-99-0</p> <p>D: 200x200mm 105254-99-0 106188-99-0</p> <p>J: 165x120mm 106617-99-0 105258-99-0 107211-99-0</p> <p>B: 90x110mm 105252-99-0 107210-99-0</p> <p>H: 170x175mm 105256-99-0 106188-99-0</p>
CALF SUPPORTS M (J) 165x120 (MESH)	105258-99-0	<input type="radio"/>				
CALF SUPPORTS L (A) 150x140 (MESH)	105250-99-0	<input type="radio"/>				
CALF SUPPORTS XL (H) 170x175 (MESH)	105256-99-0	<input type="radio"/>				
CALF SUPPORTS XXL (D) 200x200 (MESH)	105254-99-0	<input type="radio"/>				
CALF SUPPORTS S (B) 110x90 (MESH) (VS/HD)	107210-99-0	<input type="radio"/>				
CALF SUPPORTS M (J) 165x120 (MESH) (VS/HD)	107211-99-0	<input type="radio"/>				
CALF SUPPORTS L (A) 150x140 (MESH) (VS/HD)	106190-99-0	<input type="radio"/>				
CALF SUPPORTS XL (H) 170x175 (MESH) (VS/HD)	106188-99-0	<input type="radio"/>				
CALF SUPPORTS XXL (D) 200x200 (MESH) (VS/HD)	106186-99-0	<input type="radio"/>				





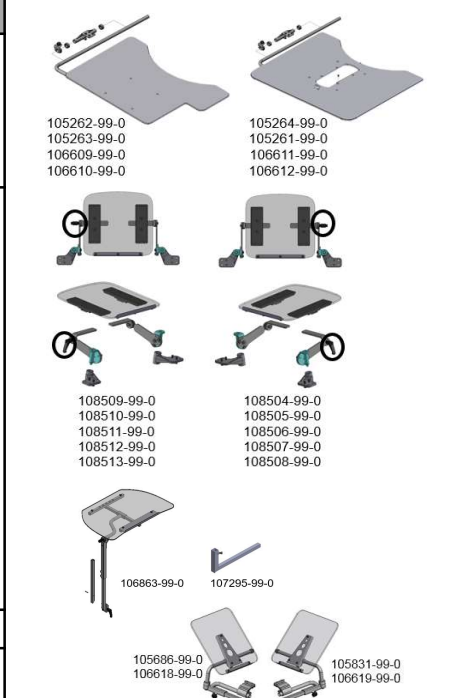













Elbow and side supports armrests					
ELBOW SUPPORT LEFT	107838-99-0	<input type="checkbox"/>			
ELBOW SUPPORT RIGHT	107839-99-0	<input type="checkbox"/>			
ARMREST SIDE SUPPORT LEFT OUTSIDE	107863-99-0	<input type="checkbox"/>			
ARMREST SIDE SUPPORT RIGHT OUTSIDE	107840-99-0	<input type="checkbox"/>			
ARMREST SIDE SUPPORT LEFT INSIDE	107865-99-0	<input type="checkbox"/>			
ARMREST SIDE SUPPORT RIGHT INSIDE	107864-99-0	<input type="checkbox"/>			
 107840-99-0 107863-99-0 107864-99-0 107865-99-0  107838-99-0 107839-99-0					
Gel pads footplates					
STEALTH GEL PADS 16CM WIDE FOOTPATES	106530-99-0	<input type="checkbox"/>			
STEALTH GEL PADS 20CM WIDE FOOTPATES	106225-99-0	<input type="checkbox"/>			
Abduction wedge					
ABDUCTION WEDGE	106762-99-0	<input type="checkbox"/>			
					
Shoulder support					
SHOULDER SUPPORT FOR 36CM WIDE BACKREST	105410-99-0	<input type="radio"/>			
SHOULDER SUPPORT FOR 41CM WIDE BACKREST	105411-99-0	<input type="radio"/>			
SHOULDER SUPPORT FOR 46CM WIDE BACKREST	105412-99-0	<input type="radio"/>			
SHOULDER SUPPORT FOR 51CM WIDE BACKREST	105854-99-0	<input type="radio"/>			
 36cm: 105410-99-0 41cm: 105411-99-0 46cm: 105412-99-0 51cm: 105854-99-0					
Stump supports					
STUMP SUPPORT SMALL (A) 150x140 TEXTILE (MESH)	106497-99-0	<input type="radio"/>	<input type="radio"/>		
STUMP SUPPORT MEDIUM (J) 165x120 TEXTILE (MESH)	106500-99-0	<input type="radio"/>	<input type="radio"/>		
STUMP SUPPORT LARGE (H) 170x175 TEXTILE (MESH)	106499-99-0	<input type="radio"/>	<input type="radio"/>		
STUMP SUPPORT XLARGE (D) 200x200 TEXTILE (MESH)	106498-99-0	<input type="radio"/>	<input type="radio"/>		
 A: 150x140mm 103067-99-0 J: 165x120mm 103068-99-0 D: 200x200mm 103071-99-0 H: 170x175mm 103070-99-0					
Knee support					
KNEE SUPPORT WITH TEXTIEL UPHOLSTERY	107285-99-0	<input type="checkbox"/>			
HOLDER KNEE SUPPORT UNITRACK	107028-99-0	<input type="checkbox"/>			
 107285-99-0  107028-99-0					
Lumbar support					
LUMBAR SUPPORT,AIR	101972-99-0	<input type="checkbox"/>			
					
Seatbelts					
CHEST STRAP BODYPOINT ELASTIC LARGE	105843-99-0	<input type="radio"/>			
CHEST STRAP BODYPOINT ELASTIC SMALL	105845-99-0	<input type="radio"/>			
SAFETY BELT,BUCKLE	100518-99-0	<input type="radio"/>			
SEATBELT, BODYPOINT 2- POINT, LARGE, NON-PADDED	104514-99-0	<input type="radio"/>			
SEATBELT, BODYPOINT 2- POINT, LARGE, PADDED	104516-99-0	<input type="radio"/>			
SEATBELT, BODYPOINT 2- POINT, MEDIUM, NON-PADDED	104518-99-0	<input type="radio"/>			
SEATBELT, BODYPOINT 2- POINT, MEDIUM, PADDED	104520-99-0	<input type="radio"/>			
SEATBELT, BODYPOINT 2- POINT, X-LARGE, PADDED	106531-99-0	<input type="radio"/>			
SAFETY BELT,AUTOTENSION	100519-99-0	<input type="radio"/>	<input type="radio"/>		
SAFETY BELT,AUTOTENSION LONG VERSION	100600-99-0	<input type="radio"/>	<input type="radio"/>		
SAFETY BELT,4-POINT	100529-99-0	<input type="radio"/>			
FOOTSTRAPS WITH PADS (SET OF 2)	103104-99-0	<input type="radio"/>			
FOOTSTRAPS WITHOUT PADS (SET OF 2)	103427-99-0	<input type="radio"/>			
 105843-99-0 105845-99-0  100519-99-0  100518-99-0   100600-99-0  104514-99-0 104518-99-0  104516-99-0 105420-99-0 106531-99-0  100529-99-0    103104-99-0  103427-99-0					

Alternative seat cushions / options					
INCONTINENCE PROTECTIVE COVER	0	<input type="checkbox"/>			
SEAT CUSHION ERGO AIR		<input type="checkbox"/>			
ROHO QUADRO SELECT		<input type="checkbox"/>			
ROHO CONTOUR		<input type="checkbox"/>			
ROHO HYBRID ELITE		<input type="checkbox"/>			
Tray tables					
TABLE,SWING AWAY 600MM FOR JOYSTICK L/R	105262-99-0	<input type="checkbox"/>	<input type="checkbox"/>		
TABLE,SWING AWAY 650MM FOR JOYSTICK L/R	105263-99-0	<input type="checkbox"/>	<input type="checkbox"/>		
TABLE,SWING AWAY 600MM FOR JOYSTICK CENTER	105264-99-0	<input type="checkbox"/>	<input type="checkbox"/>		
TABLE,SWING AWAY 650MM FOR JOYSTICK CENTER	105261-99-0	<input type="checkbox"/>	<input type="checkbox"/>		
TABLE,REMOVABLE ANGLE ADJ LEFT, WIDTH 280MM	108509-99-0	<input type="checkbox"/>			
TABLE,REMOVABLE ANGLE ADJ RIGHT, WIDTH 280MM	108504-99-0		<input type="checkbox"/>		
TABLE,REMOVABLE ANGLE ADJ LEFT, WIDTH 330MM	108510-99-0	<input type="checkbox"/>			
TABLE,REMOVABLE ANGLE ADJ RIGHT, WIDTH 330MM	108505-99-0		<input type="checkbox"/>		
TABLE,REMOVABLE ANGLE ADJ LEFT, WIDTH 381MM	108511-99-0	<input type="checkbox"/>			
TABLE,REMOVABLE ANGLE ADJ RIGHT, WIDTH 381MM	108506-99-0		<input type="checkbox"/>		
TABLE,REMOVABLE ANGLE ADJ LEFT, WIDTH 432MM	108512-99-0	<input type="checkbox"/>			
TABLE,REMOVABLE ANGLE ADJ RIGHT, WIDTH 432MM	108507-99-0		<input type="checkbox"/>		
TABLE,REMOVABLE ANGLE ADJ LEFT, WIDTH 482MM	108513-99-0	<input type="checkbox"/>			
TABLE,REMOVABLE ANGLE ADJ RIGHT, WIDTH 482MM	108508-99-0		<input type="checkbox"/>		
TABLE,ANGLE ADJUST. 1-SIDE FIXATION	106863-99-0	<input type="checkbox"/>			
BRACKET ADDITIONAL POSITION TABLE	107295-99-0				
COLLEGE TABLE,LEFT	105686-99-0	<input type="checkbox"/>			
COLLEGE TABLE RIGHT	105831-99-0		<input type="checkbox"/>		
Pouches/Bags					
ARMREST POUCH,RIGHT BLACK	107339-99-0	<input type="checkbox"/>	<input type="checkbox"/>		
ARMREST POUCH,LEFT BLACK	107338-99-0	<input type="checkbox"/>			
SEATFRAME POUCH BLACK	107340-99-0	<input type="checkbox"/>			
BACKPACK HOOKS,SET UNITRACK	105563-99-0	<input type="checkbox"/>			
BACK PACK	102059-99-0	<input type="checkbox"/>			
Other					
SUPPORT HANDLE ARMREST	106058-99-0	<input type="checkbox"/>	<input type="checkbox"/>		
TRANSFER HANDLES, SET	105260-99-0	<input type="checkbox"/>			
PUSH HANDLES	105292-99-0	<input type="checkbox"/>			
PUSH HANDLES (BACKREST 360)	105795-99-0	<input type="checkbox"/>			
CRUTCH HOLDER	105223-99-0	<input type="checkbox"/>	<input type="checkbox"/>		
HOLDER OXYGEN BOTTLE C3G	105224-99-0	<input type="checkbox"/>			
CUP HOLDER	106210-99-0	<input type="checkbox"/>			
PHONE HOLDER X-GRIP	106806-99-0	<input type="checkbox"/>			
TABLET HOLDER X-GRIP	106972-99-0	<input type="checkbox"/>			



Controls

User control						
JOYSTICK R-NET WITH 3.5" COLOR DISPLAY	107159-99-0	<input checked="" type="checkbox"/>				
JOYSTICK R-NET WITH 3.5" COLOR DISPLAY WITH BT	107779-99-0	<input type="checkbox"/>				
JOYSTICK R-NET "EL" LED	105246-99-0	<input type="checkbox"/>				
JOYSTICK R-NET HEAVY DUTY WITH COLOUR DISPLAY	105700-99-0	<input type="checkbox"/>				
MDT/RNET: JS COMPACT ADVANCED	103814-99-0	<input type="checkbox"/>				
TABLE STEERING, FLIP-OVER 600MM, BACKR. WIDTH 400	105293-99-0	<input type="checkbox"/>	<input type="checkbox"/>			
TABLE STEERING, FLIP-OVER 650MM, BACKR. WIDTH 450	105294-99-0	<input type="checkbox"/>	<input type="checkbox"/>			
NON STANDARD STEERING (SEE SPECIAL CONTROLS)	101352-99-0	<input type="checkbox"/>				
Parameters Joystick menu						
PROGR.SET: MEM RECALL VIA JS SEAT MENU OFF	104907-99-0	<input type="checkbox"/>				
PROGR.SET: MEM SAVE VIA JS SEAT MENU OFF	104927-99-0	<input type="checkbox"/>				
PROGR.SET: SEAT FUNCTIONS VIA JS SEAT MENU OFF	104917-99-0	<input type="checkbox"/>				
Joystick holder						
PANELHOLDER PARALLEL MOTION UNITRACK	107754-99-0	<input type="checkbox"/>	<input checked="" type="checkbox"/>			
PANELHOLDER SWING AWAY L=335MM	103473-99-0	<input type="checkbox"/>	<input type="checkbox"/>			
PANELHOLDER SWING AWAY L=435MM	103474-99-0	<input type="checkbox"/>	<input type="checkbox"/>			
HOLDER MIDSTEERING	104948-99-0	<input type="checkbox"/>	<input type="checkbox"/>			
BODYPOINT MIDLINE MOUNT ASSEMBLY KIT R-NET	108019-99-0	<input type="checkbox"/>	<input type="checkbox"/>			
BODYPOINT MIDLINE MOUNT ASSEMBLY KIT CJS	108020-99-0	<input type="checkbox"/>	<input type="checkbox"/>			
WITHOUT PANELHOLDER	102835-99-0	<input type="checkbox"/>				
Height adjustable holder						
HEIGHT ADJUSTABLE RIGHT JOYSTICK HOLDER	107960-99-0	<input type="checkbox"/>				
HEIGHT ADJUSTABLE LEFT JOYSTICK HOLDER	107963-99-0	<input type="checkbox"/>				
HEIGHT ADJUSTABLE JOYSTICK HOLDER	108005-99-0	<input type="checkbox"/>				
Switch box						
SWITCH BOX WITH TOGGLE SWITCHES	102799-99-0	<input type="checkbox"/>				
SWITCH BOX WITH PUSH BUTTONS	102798-99-0	<input checked="" type="checkbox"/>				
WITHOUT SWITCH BOX	104621-99-0	<input type="checkbox"/>				
Bracket switch box						
BRACKET SWITCH BOX JOYSTICK	103469-99-0	<input checked="" type="checkbox"/>				
BRACKET SWITCH BOX UNITRACK ARMREST	104651-99-0	<input type="checkbox"/>	<input type="checkbox"/>			
BRACKET SWITCH BOX BACKREST	106256-99-0	<input type="checkbox"/>	<input type="checkbox"/>			
SWITCH BOX NOT MOUNTED	105409-99-0	<input type="checkbox"/>				
Layout switch box						
SWITCHBOX(1) LAYOUT "A": SINGLE LAYER (STD)	103744-99-0	<input checked="" type="checkbox"/>				<p style="font-size: small; margin-top: 5px;">(A) 103744-99-0 (B) 103786-99-0 (C) 103787-99-0 (D) 103745-99-0 (E) 103788-99-0 (F) 103789-99-0 (L) 105832-99-0</p>
SWITCHBOX(1) LAYOUT "B": SINGLE LAYER, MEM	103786-99-0	<input type="checkbox"/>				
SWITCHBOX(1) LAYOUT "C": SWAP LAYERS, MEM	103787-99-0	<input type="checkbox"/>				
SWITCHBOX(1) LAYOUT "D": SINGLE LAYER (ALT SEQ)	103745-99-0	<input type="checkbox"/>				
SWITCHBOX(1) LAYOUT "E": SINGLE LAYER, NO TILT	103788-99-0	<input type="checkbox"/>				
SWITCHBOX(1) LAYOUT "F": SINGLE STAND, SWAP, MEM	103789-99-0	<input type="checkbox"/>				
SWITCHBOX(1) LAYOUT "L": SWAP, MEM, 5 OPTIONS	105832-99-0	<input type="checkbox"/>				

Indication level switch box					
SWITCHBOX(1) IND. LEVEL 1: NONE	103746-99-0	<input type="radio"/>			
SWITCHBOX(1) IND. LEVEL 2: SEAT FUNCTION	103747-99-0	<input type="radio"/>			
SWITCHBOX(1) IND. LEVEL 3: SPEED LIMITATION	103748-99-0	<input type="radio"/>			
SWITCHBOX(1) IND. LEVEL 4: COMPLETE	103749-99-0	<input checked="" type="radio"/>			
Extra charger connector					
EXTRA CHARGER CONNECTOR MOUNTED ON THE ARMREST	104163-99-0	<input type="radio"/>	<input type="radio"/>		
EXTRA CHARGER CONNECTOR MOUNTED ON ACC. RAIL	104164-99-0	<input type="radio"/>	<input type="radio"/>		
EXTRA CHARGER CONNECTOR MOUNTED UNDER SEAT FRAI	104165-99-0	<input type="radio"/>	<input type="radio"/>		
  					
				104163-99-0	104164-99-0
					104165-99-0
Lock Key					
LOCKING KEY R-NET	104620-99-0	<input type="checkbox"/>			
Alternative Joystick knobs					
JOYSTICK KNOB CHIN CUP	100960-99-0	<input type="radio"/>			
JOYSTICK KNOB T-GRIP	100961-99-0	<input type="radio"/>			
JOYSTICK KNOB BALL BIG	100962-99-0	<input type="radio"/>			
JOYSTICK KNOB SOFT BALL	100963-99-0	<input type="radio"/>			
JOYSTICK KNOB MUSHROOM	100964-99-0	<input type="radio"/>			
JOYSTICK KNOB STICK	100965-99-0	<input type="radio"/>			
JOYSTICK KNOB BALL SMALL	101165-99-0	<input type="radio"/>			
JOYSTICK KNOB STANDARD	101166-99-0	<input type="radio"/>			
JOYSTICK KNOB SOFT BALL BLACK (CONE)	105442-99-0	<input type="radio"/>			
JOYSTICK KNOB BODYPOINT 7.5CM U-SHAPED	105846-99-0	<input type="radio"/>			
JOYSTICK KNOB BODYPOINT 10CM U-SHAPED	105847-99-0	<input type="radio"/>			
JOYSTICK KNOB BODYPOINT RUBBER DOME	105848-99-0	<input type="radio"/>			
  					
				100960-99-0	100961-99-0
					100962-99-0
  					
				100963-99-0	100964-99-0
					100965-99-0
  					
				101165-99-0	101166-99-0
					105442-99-0
  					
				105846-99-0	105847-99-0
					105848-99-0
Attendant control					
CO-PILOT	105225-99-0	<input type="radio"/>			
JOYSTICK ATTENDANT RNET WITH 3.5" COLOR DISPLAY	107318-99-0	<input type="radio"/>	<input type="radio"/>		
ATTENDANT CONTROL JOYSTICK LIGHT LED	107320-99-0	<input type="radio"/>	<input type="radio"/>		
JOYSTICK ATTENDANT RNET SPEED/MODE	107321-99-0	<input type="radio"/>	<input type="radio"/>		
  					
				107318-99-0	107320-99-0
					105225-99-0
					107321-99-0
Emergency switch					
EMERGENCY STOP SWITCH	101792-99-0	<input type="checkbox"/>			
					
				101792-99-0	

Supplementary accessoires

(Mounting costs can apply)

MDT/RNET: JS COMPACT (LOW FORCE)	103892-99-0	<input type="radio"/>			
MDT/RNET: JS COMPACT	103817-99-0	<input type="radio"/>			
MDT/RNET: MINI JOYSTICK	105289-99-0	<input type="radio"/>			
SWITCH KIT FOR COMPACT JS (CHIN)	104641-99-0	<input type="checkbox"/>			
PANEL HOLDER ATTENDANT	105210-99-0	<input type="checkbox"/>			
CHEST SUPPORT FOR TABLE CII/VII VINYL	101303-99-0	<input type="checkbox"/>			
BLUETOOTH MOUSE 1 CONTROL	107367-99-0	<input type="checkbox"/>			
BLUETOOTH MOUSE 2 CONTROL	107368-99-0	<input type="checkbox"/>			
BLUETOOTH iDEVICE	107350-99-0	<input type="checkbox"/>			
ADAPT. CABLE BLUETOOTH MOUSE	107359-99-0	0	▼		
CHARGER USB	107189-99-0	<input type="radio"/>	<input type="radio"/>		
BUDDY BUTTON BLACK 63 MM	101766-99-0	0	▼		
BUDDY BUTTON RED 63 MM	101767-99-0	0	▼		
BUDDY BUTTON YELLOW 63 MM	101768-99-0	0	▼		
MICRO LIGHT SWITCH	101769-99-0	0	▼		
CUP SWITCH 45 MM	101770-99-0	0	▼		
MINI CUP SWITCH 24 MM	101771-99-0	0	▼		
GRASP SWITCH	101772-99-0	0	▼		
CONNECTION BOX EXTERNAL SWITCHES SEATING	104196-99-0	<input type="checkbox"/>			
CONNECTION BOX EXTERNAL SWITCHES R-NET (RBI)	104696-99-0	<input type="checkbox"/>			



Notes